



Computer Environments Incorporated

COMPUTER ENVIRONMENTS, INC.
 1616 John West Road
 Dallas, Texas 75228 - 5530, USA
 P: (214) 321-1234
 F: (214) 321-2333
 Toll Free: (800) CEI - FLOR
 234 - 3567
 Website: www.ceifloor.com
 Email: sales@ceifloor.com



Today

10GZZ 12 GR312 ZZZZZZ



1984

40GGS 24 GR112 HPL12Z2MT72B



1979

30GGS 18 GR112 HPL12Z2ST61B



1972

20AGS 12 GR112 HPL12Z2ST61B



10GZZ 06 GR112 CPT28L26584B
 With AFM 25 Electrical Box

10GZZ 06 AA812

10GZZ 06 GG708 HPL06Z2ST61B

10GZZ 06 GC116 HPL06Z2ST61B



Foreground: 30GGS 07 GR312 ZZZZZZ
Background: 30GGS 07 GR112 HPL06Z2ST61B



40GGX 12 GR115 HPL06Z2MR15B with additional pedestals on 12" (30.5 cm) centers

The CEI System

The Computer Environments system is unique in that common parts are used to construct access floor for a multitude of applications. The same basic components are used to construct 2 1/2" (6.3 cm) through 72" (183 cm) finish floor heights. All panels fit on all understructure and all coverings fit on all panels (carpet cannot be perforated). This allows the user to make future changes in panels and/or covering with minimal effort.

- FIRE:** All systems comply with NFPA 75 fire rating standards.
- ELECTRICAL:** Floor panels and understructure are constructed of galvanized steel for corrosion resistance and electrical continuity preventing static buildup.
- COMFORT:** Resiliency, thermal insulation and sound absorption are integral to design.
- ENVIRONMENT:** Panels and understructure (excluding covering) are constructed of 99 percent renewable or recyclable materials. Since the CEI product is lighter – 29 pounds (13.2 kg) for the GR112 series – than competitors, precious fuel is not wasted during transportation.
- PRECISION:** Die cut components assure system parts are interchangeable.
- VERSATILITY:** Panels and understructure can be combined to meet a variety of load requirements. Panels span 24" x 24" (61 cm x 61 cm) for maximum underfloor open area. As shown in the top right photograph, additional pedestals and grid can be installed increasing vertical loading capacity of the floor system.
- ENGINEERING:** Flooring can be adapted to any seismic zone and most rolling load requirements.
- ACCESS:** Panels are easily removable using suction lifting devices.
- INSTALLATION:** CEI floor panels are lighter and easier to cut than panels of similar strength made of concrete or all steel.
- ACCESSORIES:** ADA compliant ramps, steps and handrails are all stocked in ready to assemble kits. Perforated panels, electrical outlets, air diffusers, panel lifters, cable tray and trim are all in stock ready to ship with your order.
- PRICE:** Our floor panel design provides the highest strength to cost ratio available and strength to weight ratio superior to concrete panels.
- DELIVERY:** Our enormous inventory and rapid response manufacturing techniques allow shipment of most orders in a few days.
- SOURCE:** Computer Environments Inc. is 100 percent US owned and our products are 100 percent US made. We are not a front for a foreign owner nor do we purchase foreign product and resell it.



10GZZ 24 GR312 ZZZZZZ stair stepping down to 6" high and up to 12" high in background



40AGS 14 GR112 HPL06Z2ST61B

4 0 G G X 12 GR 1 12 HPL 06 Z 2 ST 61 B

Understructure type
(1=10 series, 2=20 series, 3=30 series, 4=40 series, or 5=50 series)

Pedestal type (0=standard tube or 1=heavy tube)

Pedestal material of construction (A=aluminum, G=galvanized steel or S=stainless steel)

Grid material of construction (A, G or S)

Grid configuration
S=2' x 2' for 20 and 30 series, 2' x 6' for 40 and 50 series
X=4' x 4' basket weave for 40 and 50 series
Z=Not applicable (pedestal only)

Finished floor height (in inches)

Panel shell material of construction (A, G or S)

Panel core material of construction
R=Resin fiber (solid panel only)
C=Cementitious composite (solid panel only)
A, G, or S=Perforated panel

Panel type
1=Solid panel with factory finish and edge trim
2=Solid panel, no edge trim, field or factory applied covering.
3=Corner lock solid panel, no edge trim, field applied covering.
7=Perforated panel
8=Aluminum high volume perforated panel

Concentrated load rating
08=800 pound perforated panel (any alloy)
10=1000 pound aluminum perforated or aluminum solid panel
12=1250 pound perforated or solid panel (any alloy)
15=1500 pound perforated or solid panel (any alloy except perforated aluminum)
16=1600 pound galvanized steel or stainless steel solid panel
20=2000 pound galvanized steel or stainless steel solid panel

Trim edge color (B=black, N=brown, Z=none)

Color (see page 6 and 7)

Static rating

1=No rating

2=1 x 10⁶ - 2 x 10¹⁰ Per NFPA 99 or for carpet, < 2 kV per AATCC 134

3=Not in current production

4=2.5 x 10⁴ - 1 x 10⁶ Per NFPA 99

Pile type for carpet

C=Cut pile

L=Loop pile

Z=Not applicable

Thickness or face weight

06=1/16" (1.6 mm) thickness, high pressure laminate (HPL) only

12=1/8" (3.2 mm) thickness, HPL or vinyl

28=Ounces per square yard yarn weight for carpet

ZZ=Field applied covering

Material Type

CPT=Factory applied carpet

CVT=Conductive vinyl tile

HPL=High pressure laminate

ZZZ=Field applied covering

Series 10, 20, and 30

Computer Environments, Inc. offers two pedestal design systems. The pedestal shown on this page is used with our 10 series (pedestal only), 20 series (lift out grid) and 30 series (bolted grid) understructure configuration. It is normally used in general office and smaller computer rooms where loading is light and the threat of seismic activity is low. The pedestal shown on the following page is used with our 40 and 50 series system which supports heavy rolling loads on taller access floors (typically large computer rooms) as well as seismically active areas. All panels are compatible with all understructure. Understructure is available in galvanized steel (standard), aluminum, or stainless steel. Galvanized head, tube and grid facilitate electrical continuity and resist corrosion.

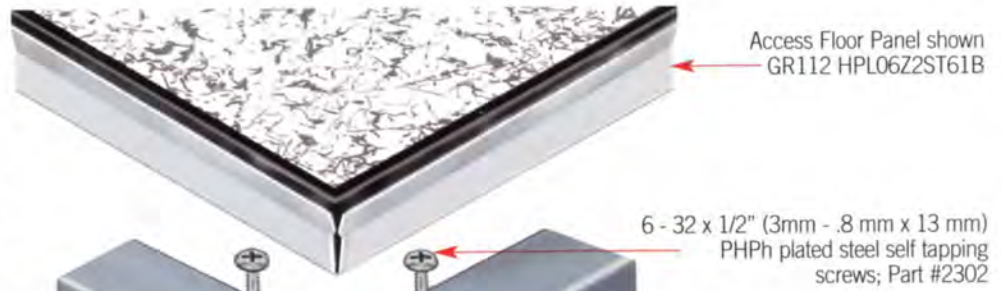

Access Floor Panel shown
GR112 HPL06Z2ST61B

6 - 32 x 1/2" (3mm - .8 mm x 13 mm)
PPh plated steel self tapping
screws; Part #2302

16 gauge (1.5 mm) galvanized steel
grids mate with tab for lateral stability
or can be bolted to pedestal head.
Grids provide 24" (60.96 cm)
pedestal spacing; Part # 2301

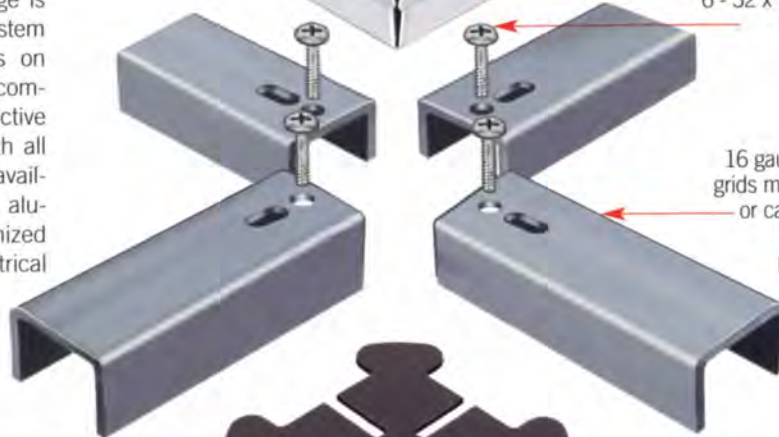

Electrically conductive grounding pad
reduces noise; Part # 2300



Cleats maintain panel alignment

1/4" - 20 (6.3 mm - 1.27 mm)
holes for corner lock panels
are factory tapped

7/8" x 16 gauge (2.2 cm x 1.3 mm) galvanized
tube supports 10,000 lbs. at 12" FFH (44.48 kN at
30.48 cm) and 5,000 lbs. at 24" FFH (22.24 kN at
60.96 cm); heavier tubing is available
for higher loads

Swedge in stud prevents
rotation and accidental over height
adjustment

3/4" - 10 solid steel (1.9 cm - 2.54 mm)
5" (12.70 cm) long threaded stud
provides 3 3/4" (9.52 cm) vertical
adjustment; available plain (standard) or
galvanized



Recessed landing for grid

11 gauge (3mm) galvanized head is set
at 45 degree angle to floor so no sharp
corners extend into opening when panel
is removed; Part # GH1012 head
assembly shown

Ears on nut engage
tube and prevent
accidental adjustment



4" x 4" x 1/8" (10 cm x
10 cm x 3 mm) galvanized
steel base withstands 1,000 inch
pounds (113 Nm) overturning
moment; Part # GB5 base assembly



Series 40

10270/COM
BuyLine 3202

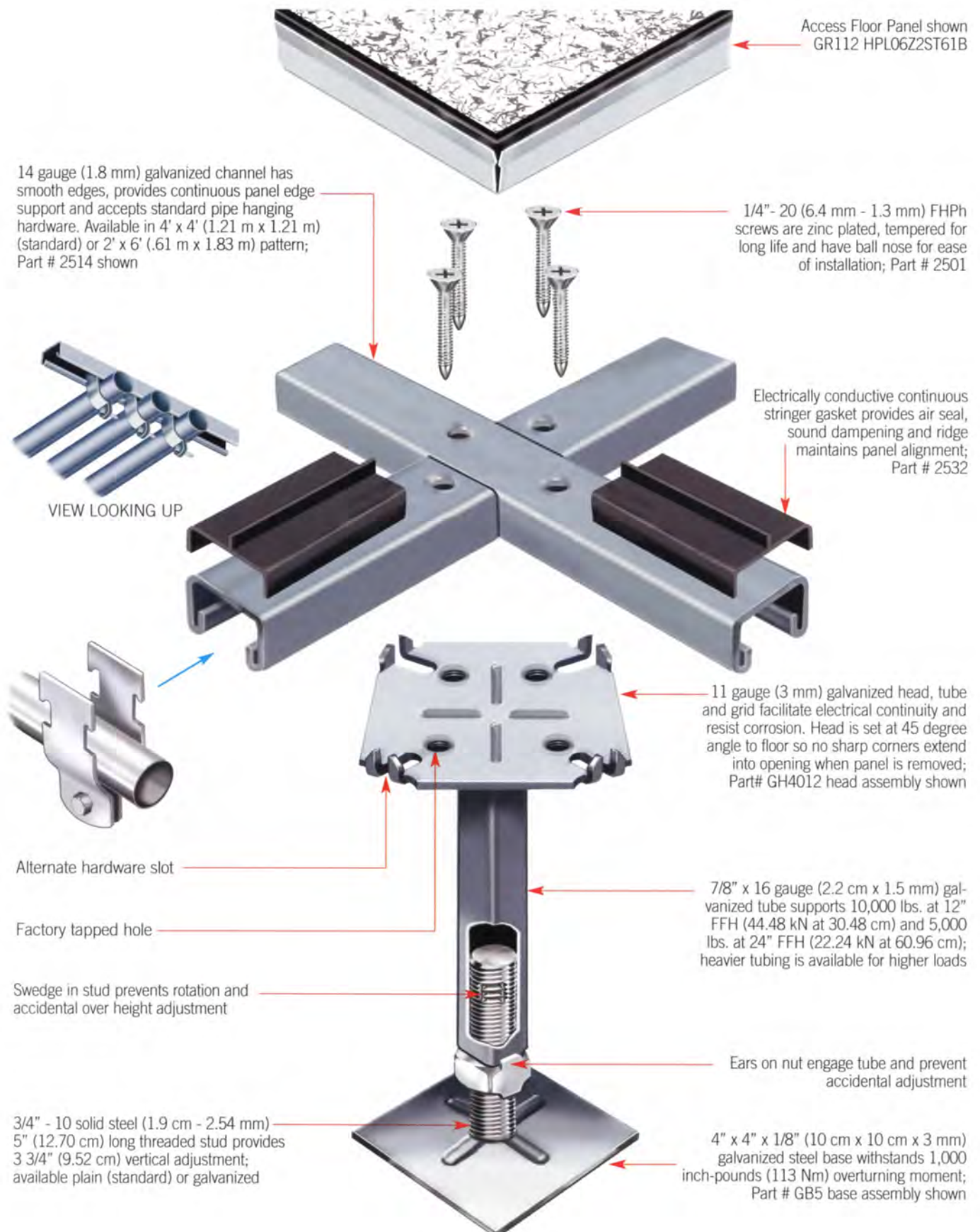

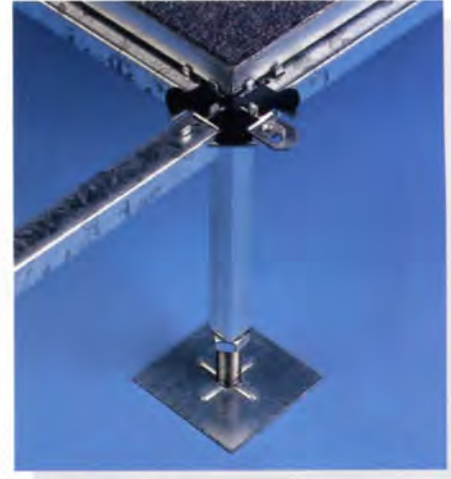
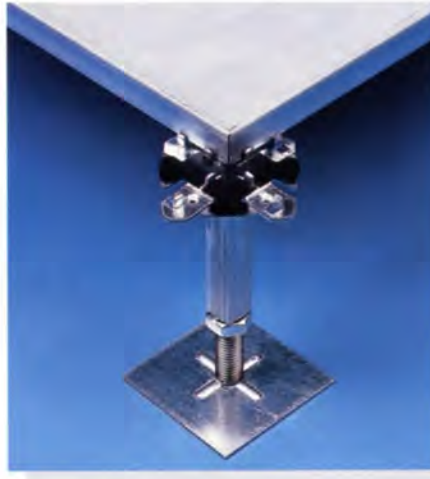
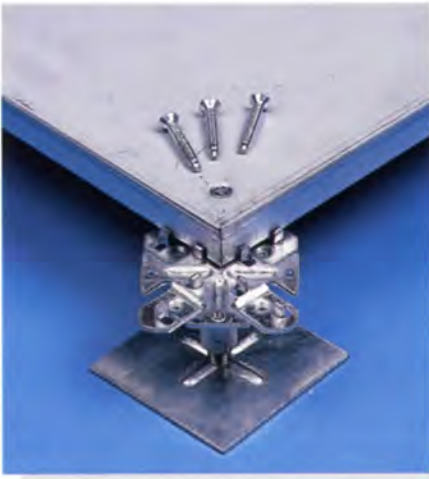

10 Series (Pedestal Only)
10GZZ 03 GR312 ZZZZZZ

Galvanized steel corner lock panel and pedestals in 3" (7 cm) finished floor height (FFH).

System accepts field installed carpeting. Bolted panels assure quiet stable system. With a minimum height of 2 1/2" (6 cm), the system is ideal for any area where a low ceiling restricts floor height. The system allows installation of standard electrical hardware. Low floor height will not permit the access floor to be used as an air supply plenum. Drain piping must have a 1 percent slope. Panels with factory finish can also be used.

10 Series (Pedestal Only)
10GZZ 08 GR212 ZZZZZZ

Galvanized steel gravity held panel and pedestals in 8" (20 cm) FFH.

System accepts field installed carpeting; panels are also available with factory finish. Available from 4" (10 cm) to 12" (30 cm) FFH. Rooms larger than 1,000 square feet (92 square meters) will often need several inches underfloor clearance for crossing piping and junction boxes. The system allows installation of standard electrical hardware. Good choice for open office and small computer rooms where loading is light. Cannot be used in seismically active areas.

20 Series (Lift Out Stringer)
20GGS 12 GR212 CPT28L13405Z

Galvanized steel gravity held panel with factory applied, <2kV AATCC test 134, monolithic carpet shown on pedestals in 12" (30 cm) FFH.

Available from 4" (10 cm) to 24" (61 cm) FFH. This understructure is a good choice for small to mid size rooms. Lift out stringers provide quick access to underfloor while providing lateral stability. Hard surface panels should be used where frequent underfloor access is required or caster traffic is present. Factory carpet is ideal for light traffic areas where panels are not often removed.

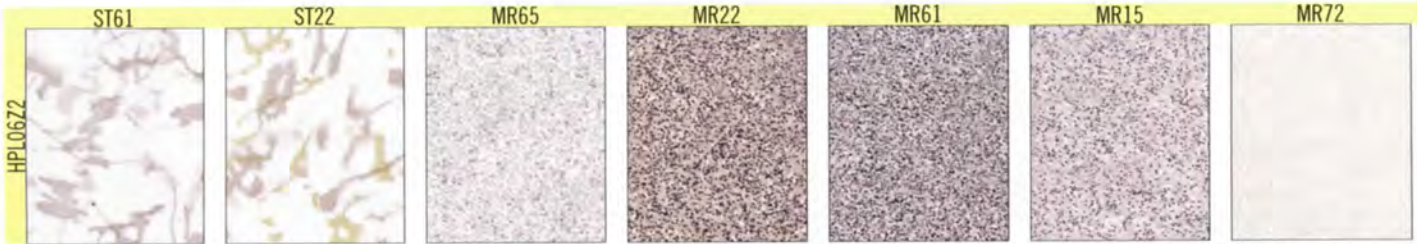

ST61 and ST22 are standard high pressure laminate colors. All others are designer colors available at a slightly higher cost. All have an NFPA 99 electrical resistance

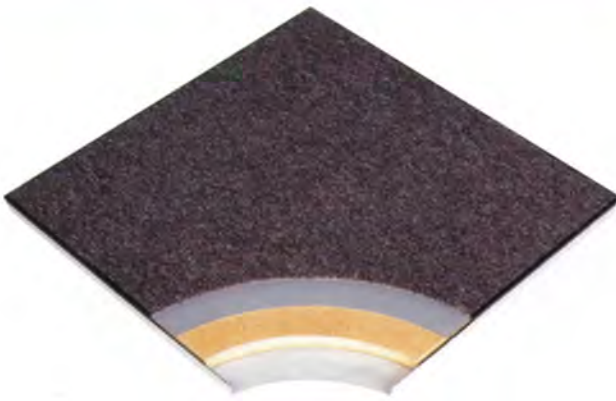

GR112 CPT28L23405B

Load Performance							
Panel		Static	Ultimate	Ultimate Impact	10,000 Pass Rolling On:		
					10 series	40 series	50 series
AR or AC110	lbs	1000	2400	275	500	700	1000
	kg	454	1089	125	227	318	454
AR or AC112	lbs	1200	2800	300	600	800	1100
	kg	544	1270	136	272	363	499
GR or GC112	lbs	1250	2900	300	600	800	1100
	kg	567	1315	136	272	363	499
GR115	lbs	1500	4000	400	750	950	1250
	kg	680	1814	181	340	431	567
GC116	lbs	1600	5500	450	750	1600	1700
	kg	726	2495	204	340	726	771
GR or GC120	lbs	2000	5500	450	750	1700	2000
	kg	907	2495	204	340	771	907

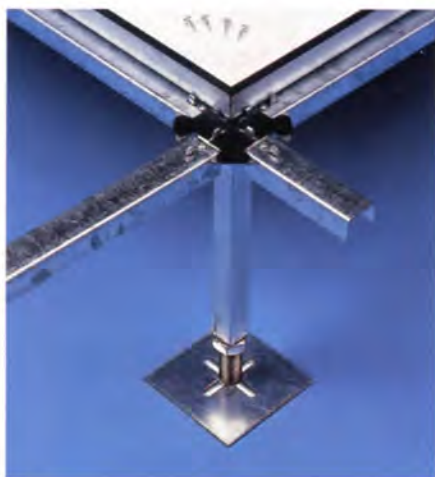

30 Series (Bolted Stringer)
30GGS 12 GC116 HPL06Z2ST61B

Galvanized steel gravity held panel with factory applied low static, no wax high pressure laminate, color ST61, shown on galvanized steel pedestals in 12" (30 cm) FFH.

Available from 4" (10 cm) to 24" (61 cm) FFH. Understructure is a good choice for mid size computer rooms. Bolted stringers provide rigidity and positive electrical continuity throughout the understructure. Locked in trim and durable surface will provide a low maintenance work platform for many years.

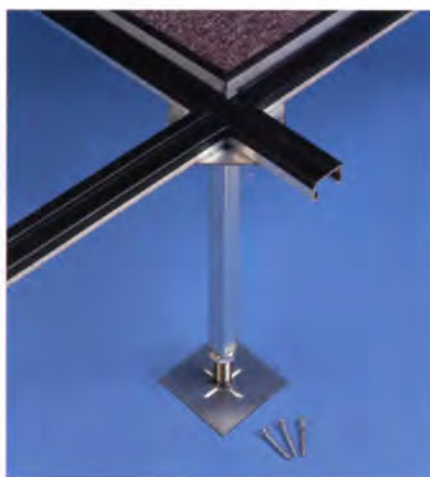

40 Series (Bolted Framing)
40GGX 18 GR112 CPT28L13405B

Galvanized steel gravity held panel with factory applied, low static (<2kV AATCC test 134), loop pile carpet, color 3405, inset into panel trim edge, shown on galvanized steel pedestals in 18" (46 cm) FFH. Available from 5" (12 cm) to 72" (183 cm) FFH.

This is our most popular understructure. Channel is available in standard 4' x 4' (122 cm x 122 cm) basket weave or 2' x 6' (61 cm x 183 cm). Enhances rolling load strength of floor panel by providing continuous edge support. Basket weave increases lateral stability by 50 percent.

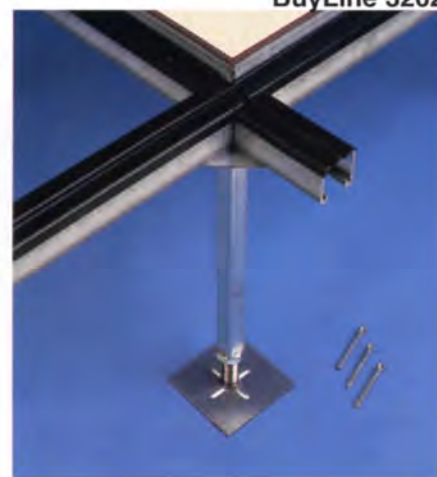

50 Series (Bolted Framing)
50GGS 18 GR115 HPL12Z2ES21N

Galvanized steel gravity held panel with factory applied, low static, no wax high pressure laminate, color ES21, brown trim shown on galvanized steel pedestals in 18" (30 cm) FFH.

Available from 6" (15 cm) to 72" (183 cm) FFH. Channel is available in standard 4' x 4' (122 cm x 122 cm) basket weave or 2' x 6' (61 cm x 183 cm). Enhances rolling load strength of floor panel by providing continuous edge support. Basket weave increases lateral stability by 50 percent. This understructure would normally be used with stronger panels (GR115 or GR120).

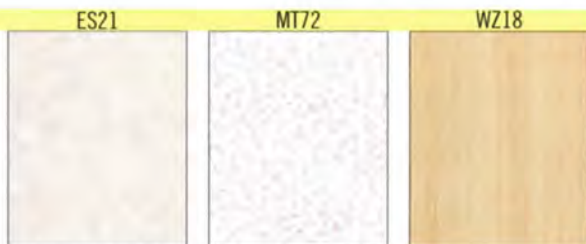

of between 1×10^6 and 2×10^{10} ohms.

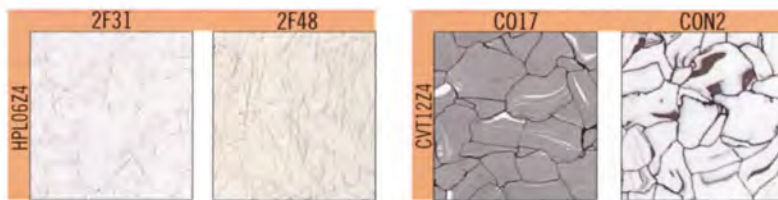

These colors have an NFPA 99 electrical resistance of between 25,000 and 1,000,000 ohms. C017 and CON2 are 1/8 inch (3mm) thick solid vinyl. These colors are about twice the price of standard coverings.



0119

0114

3435

3431

0117

2302

3438

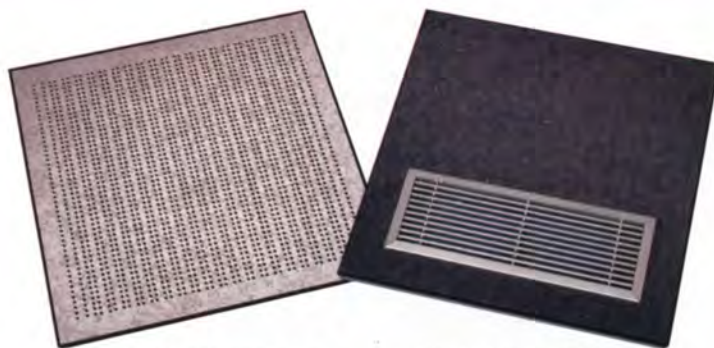

GG708 HPL06Z2ST61B

GR112 CPT28L23405B
with model 4300 air grille

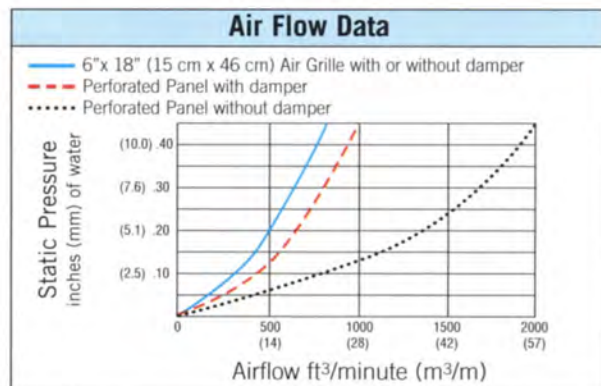

NOTE: Most HVAC units are rated at .5" Ext. S.W.G. Normally about 20% (.1" S.W.G.) of this available pressure should be used through the perforated air panels at the rated C.F.M.



Pictured at left are three methods of attaching GB5 bases: adhesive only, self threading concrete screws and wedge anchors. The left most base has a standard projection weld with standard adhesive providing 1000 inch pounds (113 Nm) overturning moment. Middle and right bases are fillet welded and bolted increasing overturning moment to 1500 inch pounds (169 Nm). Bases can also be supplied with larger and thicker plate for more strength.

ADA compliant ramps, facia, handrails and steps are all available in ready to assemble kits. Kits are customized by the factory to match your project requirements.



Two pictures at left top show our premium floor outlet box with hinged load bearing lid and sample receptacles.



Two pictures at left are economy boxes with snap in non load bearing lids. Either box will accept plug in wiring systems or can be hard wired.



Clockwise at left:
2700: vacuum panel lifter
2703: wall mount lifter bracket
2702: lifter for panel with factory applied carpet

4107: 2" (5.08 cm) grommet
4106: 3" (7.62 cm) grommet
4105: 4" (10.16 cm) grommet



Standard cable cut outs with L trim K4108 = black, N4108 = brown, 4' (122 cm) lengths

2' x 2' x 4" deep (61 cm x 61 cm x 10 cm) cable tray module

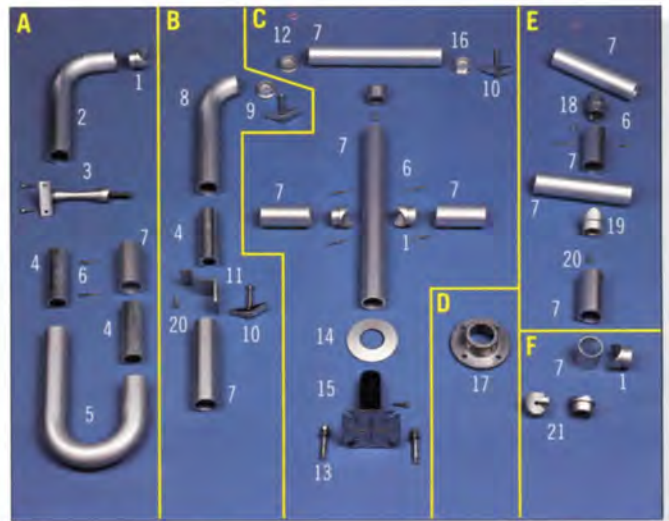

A. Parts for slope rail mount handrail

1. 3701: 90 degree aluminum tee fitting
2. 3719: 5 7/8" 90 degree horizontal to slope rail return
3. 3716: 6" CL to CL vertical to horizontal offset
4. 3715: Aluminum pipe splicing sleeve
5. 3720: 7 7/8" 180 degree horizontal to slope rail return
6. 3704: 1/8" X 5/8" stainless steel pop rivet
7. 3700: 1 1/2" nominal ID, 1.9" OD clear anodized aluminum pipe

B. Parts to wall mount handrail

8. 3713: 3 7/16" 90 degree handrail wall return
9. 3718: Aluminum end cap machined to fit in wall return with 3/8" hole
10. 3711: 3/8" X 3" Butterfly bolt
11. 3710: Aluminum wall mount bracket

C. Parts for through floor mounted horizontal rail

12. 3709: Aluminum end cap
13. 3921: 1/4" X 1 3/4" Hex head self threading concrete screw
14. 3706: Aluminum handrail cover flange
15. 3707: Steel handrail base
16. 3717: Aluminum end cap with 3/8" hole (wall mount)

D. 17. 3708: Aluminum handrail base for exposed surface mounting

E. Parts for free standing slope rail

18. 3722: 26 degree aluminum tee fitting
19. 3702: 4.7 degree aluminum tee fitting
20. 3705: #12 X 1" hex head self drilling BA screw

F. Parts for corner post

21. 3703: 90 degree aluminum corner tee fittings

COMPUTER ENVIRONMENTS, INC.

1616 John West Road
Dallas, Texas 75228 - 5530, USA
P: (214) 321-1234
F: (214) 321-2333
Toll Free: (800) CEI - FLOR
234 - 3567
Website: www.ceifloor.com
Email: sales@ceifloor.com